

efergy.com

efergy

Instructions

Before operating and installation carefully read all instructions.



At the end of its serviceable life, this product should not be treated as household or general waste. It should be handed over to the applicable collection point for the recycling of electrical and electronic equipment, or returned to the supplier for disposal.

How to contact us:

If you have any questions about using your efergy monitor, or if you'd like further advice about energy saving at home or at work, please feel free to contact us: Call efergy on +44 (0) 8450177 769

efergy will answer any installation or set-up questions and offer quick energy saving tips. Lines are open between 8.30am and 5pm Monday to Friday. You can also email us: info@efergy.com. Further information is also available at www.efergy.com



CE1622

RoHS



efergy.com

CONTENTS

INTRODUCTION	3
SAFETY	4
IN THE BOX	5
FIND THE FEED CABLE	6
INSTALLATION	8
LINKING TRANSMITTER AND DISPLAY	9
SETTING TIME AND DATE	10
SET-UP INSTRUCTIONS	11
DUAL TARIFF MODE	13
HOW TO CHANGE FUNCTIONS	15
HOW TO CHANGE MODES	16
HOW TO CHANGE THE DATE	17
FAQs	18
SPECIFICATIONS	19

INTRODUCTION

Energy metering and monitoring are at the heart of energy management: you need the information to tell when and where you're saving money.

The efergy Wireless Electricity Monitor shows the amount of energy that a household is consuming at the time the display is read. The display can also give the user a reading showing usage in financial terms. You can walk around the home with your display device, switching appliances on and off, and see the difference that this makes.

How to contact us

If you have any questions about using your efergy monitor or if you'd like further advice on monitoring electricity at home, please feel free to contact us, or visit the website for up to date information, downloads, and frequently asked questions.

Email your questions at info@efergy.com

We aim to answer all emails within 48 hours.

efergy Customer Service. T +44 (0) 8450 177 769

SAFETY

IT IS IMPORTANT THAT YOU OBSERVE SOME SIMPLE PRECAUTIONS BEFORE USING THIS PRODUCT.

When installing the efergy monitor you should find that everything is relatively straight-forward. However, there are number of important health and safety issues which you need to be aware of.

The sensor clip fits onto the internal live feed cable inside the electricity meter, which delivers the live supply to your home.

Please read and act upon the important information on the following pages. Remember the device is not intrusive and does not require any rewiring.

If you notice anything unusual about the electricity supply, such as loose wires, exposed cabling, burn marks, holes in the insulating materials or damage to the meter, then stop immediately and report the findings to your electricity supplier.

Do not force or bend the cables at any point during the installation. If you are worried or have any concerns about the installation, please contact a qualified electrician immediately.

The user does not need to remove the sensor through the working life of the unit. Battery changes are performed on the transmitter and on the display. There are no batteries to change in the sensor.

IN THE BOX

Your efergy Pack contains the following elements:

- 1x Sensor
- 1x Transmitter
- 1x Display Unit

You will need to fit the sensor to the live feed cable which connects the meter to the consumer unit. Any power you use in your home will pass through this cable. The clip-on sensor acts as a current sensor, and relays the amount of current being drawn in the home to the transmitter. From there it is sent wirelessly to the monitor display unit, which shows how much power is being consumed.

It also includes:

- 1x USB cable
- 1x Energy saving guide
- 1x CD ROM with the energy management software
- 1x Instruction manual for the monitor
- 1x Instructions manual for the software

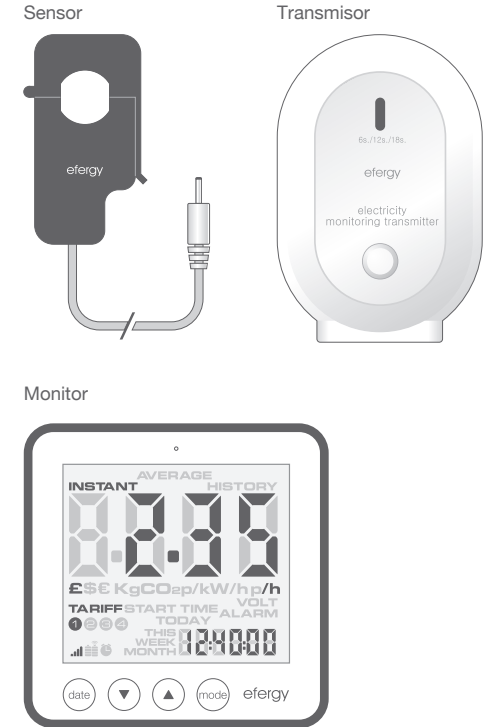

FIND THE FEED CABLE

The efergy monitor is installed by clipping the sensor around the feed cable of your electricity meter.

LOCATE YOUR ELECTRICITY METER

Locate your electricity meter and determine its type. You can normally find this on an outside wall, in the garage, basement or utility room. If you live in a flat, it can often be found outside your front door, in the communal stair case, or in the basement. Ensure there is enough of accessible cable coming from the bottom of your electricity meter.

Modern office blocks and apartments may have safety panels to protect wires entering the meter. It is recommended that professional electricians be contacted where this is the case.

FIND THE FEED CABLE

You should find four cables exiting the meter. The feed cable (Cable 4) is the live cable exiting from the meter to the fuse box. Connect the sensor to Cable 4 (Cable 4 will generally be on the right hand end of the meter, see Diagram 1).

Some installations will have Cable 1 and Cable 2 covered, or partially covered to prevent any tampering with the supply (see Diagram 2). Attach the sensor to Cable 4 (far right cable).

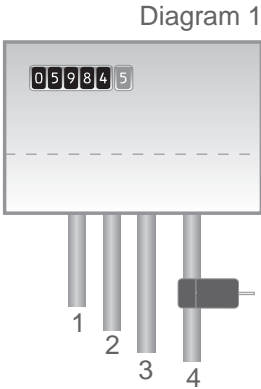
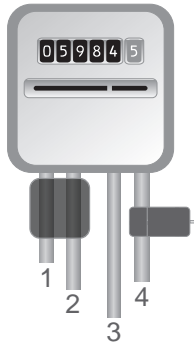

Diagram 2



Dual Tariff meters (Diagram 3) will often have an Auxiliary cable running between Cable 3 and Cable 4. Auxiliary cables will be smaller in diameter than the feed cables, and will run into an adjoining metering device.

Newer installations will normally have two cables exiting from the bottom of the meter. One is the earth cable, the other the live feed cable. The sensor should be clipped around the live feed cable (this is normally brown coloured).

If you have a three phase supply, or economy 7 meter, then you may require additional sensors. These can be simply plugged into the additional sockets at the base of the transmitter. Please contact your supplier for additional sensors.

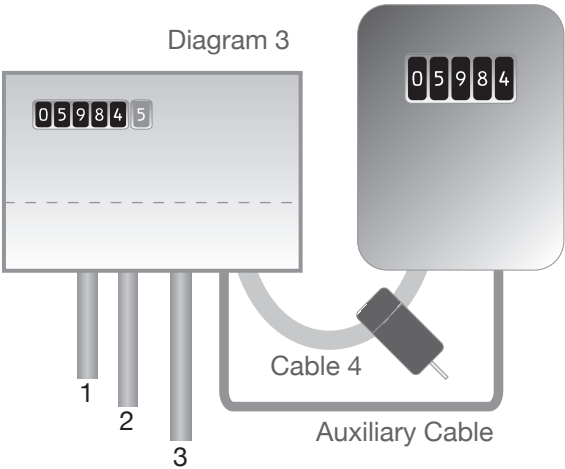

Safety

UNDER NO CIRCUMSTANCES SHOULD YOU TRY TO ATTACH THE SENSOR IF THERE IS ANY DAMAGE TO THE ELECTRIC METER CABLES. NO CABLES NEED TO BE CUT. DO NOT CUT ANY CABLES.

CONTACT YOUR LOCAL ELECTRICITY SUPPLIER IF YOU HAVE ANY CONCERNS ABOUT CLIPPING THE SENSOR ONTO THE CORRECT CABLE.

INSTALLATION

1. FIT THE SENSOR

The sensor needs to be fitted to the live feed cable. Sensors are suitable for cables up to 12mm in diameter. You should not force the cable to fit.

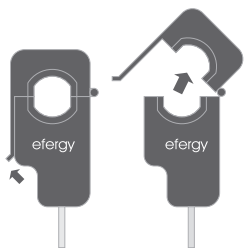

1. Push the release cap to open the sensor.

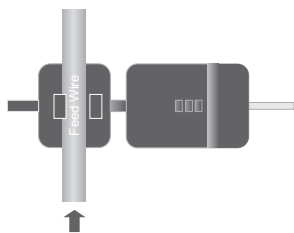

2. Select the correct feed cable, then place the feed cable into the top of the sensor.

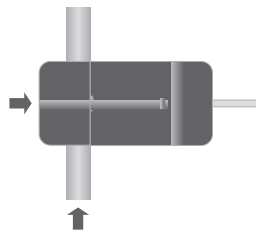

3. Close the sensor. The sensor is secure when a "click" is heard.

2. PLUG THE SENSOR CABLE INTO THE TRANSMITTER

Insert the jack on the end of the white wire into any of the three input sockets on the transmitter. The clip-on sensor acts as a current sensor and relays the current being drawn in to the home to the transmitter.

If your cables are too big for the sensor you can order XL-sensors at www.efergy.com

LINKING TRANSMITTER AND DISPLAY

1. Ensure three AA batteries are inserted in the transmitter and three AAA batteries inserted in the display unit.

2. Push the LINK button on the reverse of the display unit. The transmission signal symbol will flash for one minute.

3. While the transmission signal in the display flashes push the learn button in the transmitter and wait until the transmission signal symbol becomes solid.

NOTE: The default value for the transmission frequency is six seconds. This means the transmitter is sending information every six seconds. You can change the frequency from 6s (red light flashing) to 12s (green light) and to 18s (orange light) pushing and holding the transmitter button.



If the LINK is COMPLETED you will see the transmission signal



transmission signal

If the LINK is NOT COMPLETED you will see dashes on the display

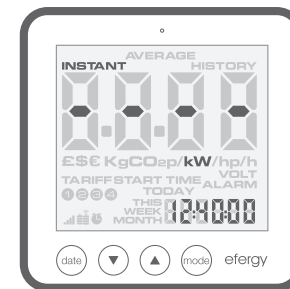

SETTING TIME AND DATE

The efergy monitor needs to know the time and date in order to provide you with the correct information.

Set the time and date as follows:

STEP 1

On the reverse of the display you will find the TIME button. Press and hold for two seconds. Time set up will flash in the display.

STEP 2

Set the hour to the correct time by using UP and DOWN buttons. Press MODE button once to save the hours. Repeat for minutes, using the MODE button to confirm.

STEP 3

Set the date by using the UP and DOWN buttons. Press MODE button to confirm and move to month set up. Repeat the process to set the year. Once the correct time and date have been set, push DATE button to save and exit.



efergy.com

SET-UP INSTRUCTIONS

The efergy monitor needs to know unit cost per kWh charged by your electricity supplier, along with voltage and alarm settings. The following four steps will move through each of these settings. If you have dual or multiple tariff rate meter, please see overleaf.

Press and hold down MODE button for two seconds, this will enable you to enter the setting mode.

STEP 1. VOLTAGE

Press and hold MODE button for two seconds. Default voltage is set at 240V. Use UP and DOWN buttons to change the voltage. Press MODE button to save your setting and move into currency selection setting.

STEP 2. CURRENCY SELECTION

Select the currency using UP and DOWN buttons. Default currency will be “£”. Push MODE button to confirm and to move onto tariff selection set up.

Note: 20 seconds of inactivity in setting mode will return the unit to normal display mode without saving changes.

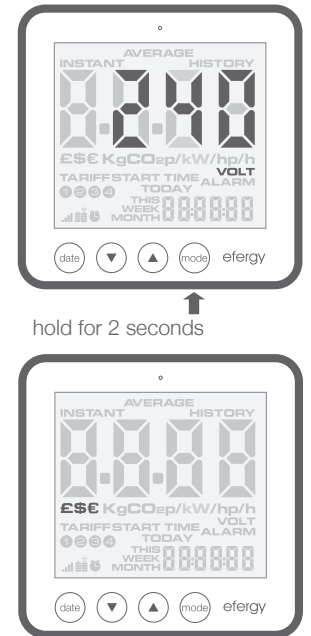

DUAL TARIFF MODE

STEP 3. SINGLE TARIFF SET UP

On release you will see the symbol “TARIFF 1” flash. If you are charged one single tariff push MODE button to confirm. If you have dual tariff rate, please see overleaf.

QUICK HINT:

Throughout the set-up process, push DATE button at any time, your settings will be saved & you will exit the function setting mode.

STEP 4. ELECTRICITY COST

Default cost is set at 14p/kWh. This is the average price per kWh electricity that suppliers charge in the UK. Use UP and DOWN buttons to change the cost per kWh. Press MODE button to save your setting and to move onto alarm setting.

STEP 5. ALARM

Default Alarm is set at 5kW. If the alarm function is switched on, and you are using more than 5kW, the alarm will sound and a red light will glow from the button of the display unit. This value can be decreased or increased using UP and DOWN buttons. Press MODE button to store the value. Press DATE button to exit the function setting mode. To activate and deactivate the Alarm at any time push ALARM button on the reverse of the display.

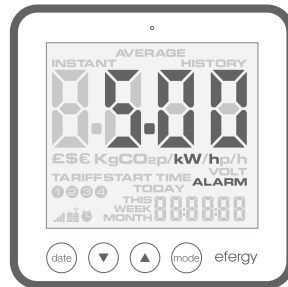
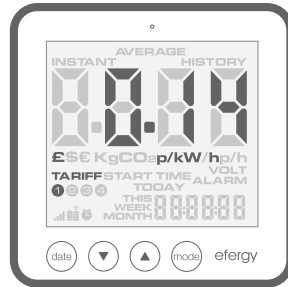
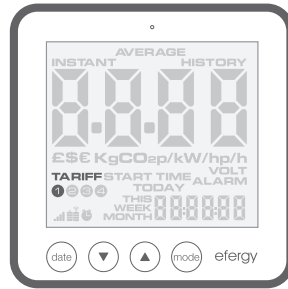

If you have a dual or multiple tariff rate meter you may want to set-up the dual tariff function.

STEP 1. ACTIVATION OF DUAL/MULTIPLE TARIFF

Press and hold MODE button for two seconds. On release you will see the voltage setting flash. Press MODE twice and you will move onto the tariff selection setting.

Now you will see the symbol “TARIFF 1” flash. Press UP or DOWN buttons to select dual or multiple tariff set up (you can select up to 4 tariffs). Push MODE button to confirm. Now you have to set START and END times periods for each tariff.



2 seconds ↑

STEP 2. SET START & END TIME FOR TARIFF 1

Set the start time for TARIFF 1 first using UP or DOWN buttons. Set the hours and press MODE button to save and move to minute set up. Set minutes using UP or DOWN and pushing MODE button to confirm. Repeat the process for third and fourth tariffs if you have multiple tariff settings. You will always set one period of settings less than the number of tariffs you have selected as the remaining period will be saved automatically.



STEP 3. ELECTRICITY COSTS - TARIFF 1

Default price of 15p/kWh will flash. Use UP and DOWN buttons to change the cost per kWh. Press MODE button to save your setting. Tariff 2 set up will flash.

STEP 4. ELECTRICITY COSTS - TARIFF 2

Default price of 5p/kWh for Tariff 2 will flash. Use UP and DOWN buttons to change the cost per kWh. Press MODE button to save your setting.

STEP 5. ELECTRICITY COSTS - TARIFF 3 & 4

Default price of 15p/kWh for Tariff 3 will flash. Use UP and DOWN buttons to change the cost per kWh. Press MODE button to save your setting. Repeat the process for tariff 4.

Example: If you are on an economy-7 tariff which starts at 1am and finishes at 8am, set start time at 01:00 and end time at 08:00. Push the MODE button to confirm. Select the currency and set the cost per kWh you pay for each tariff, approx 5p/kWh and 12p/kWh for night and day time rates respectively.

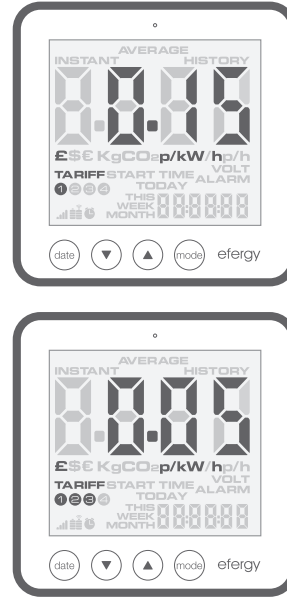

HOW TO CHANGE FUNCTIONS

FUNCTION BUTTON: Press the top FUNCTION button to change the information displayed from instant to average and to history.

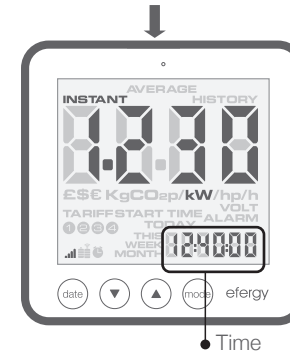

INSTANT

The display unit shows instant power (kW), estimated electricity costs per hour (£/hour) and carbon emissions per hour (kg.CO2/hour).

The LED light will flash every 6s, 12s or 18s in the top of the display indicating the time of use:

- Red: highest cost period
- Green: low cost period

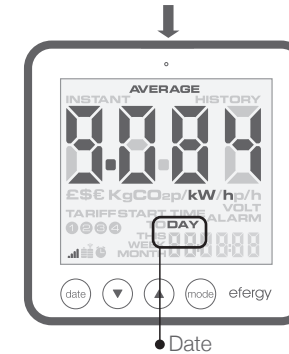

AVERAGE

The information shown is the average calculated since the monitor was switched on for the first time. It shows daily, weekly and monthly average consumption in kWh, £ and kg.CO2.

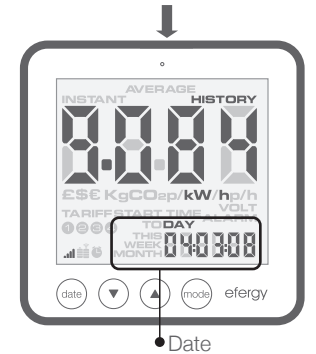

HISTORY

At this mode the monitor shows consumption of the last 7 days, last 7 weeks and last 24 months in kWh, £ and kg.CO2.

HOW TO CHANGE MODES

MODE BUTTON: Press MODE button to change the unit displayed

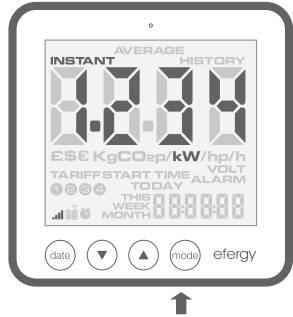

POWER
Shows the power of your whole house at any instant, in kW.

ENERGY
At average and history modes the display shows energy consumption, in kWh.



COST PER HOUR
Estimates the electricity cost of your home as if all appliances and lights were running for an hour (£/hour) at that instant.



CARBON EMISSIONS
Estimates the indirect carbon footprint for electricity consumption as if all appliances and lights were running for an hour (kg.CO2/hour) like at that instant.

HOW TO CHNAGE THE DATE

DATE BUTTON: Press DATE button to choose from daily, to weekly and to monthly data.

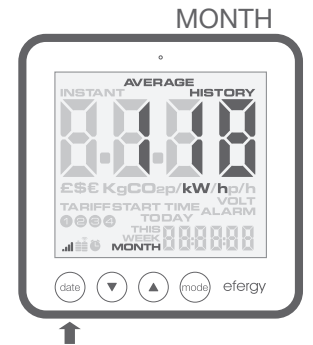
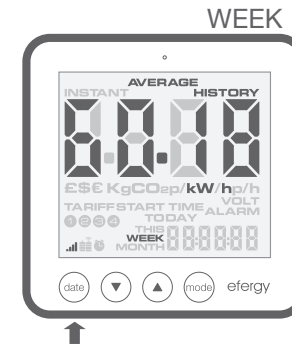
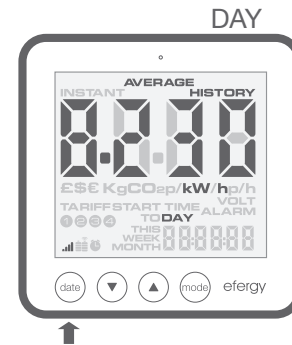

ARROWS: At history mode the arrows are used to scroll between date, weeks and months.

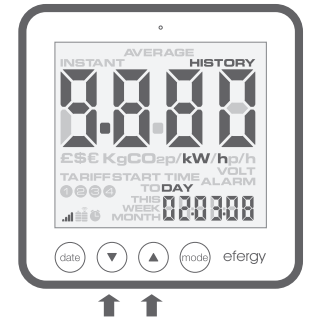

FREQUENTLY ASKED QUESTIONS

If I remove the batteries will I lose the information on the display?

If you need to change or remove the batteries, the display has an internal memory, so information stored on the display will not be lost.

How do I reset the display (clear the data and start again)?

Press MODE and DATE buttons simultaneously and hold for two seconds.

How far does the device transmit?

Transmitter's works around 40meters within the home. The 433MHz range is well suited for in home use. This can cover three floors, and also well suited to builders where meters are outside the main building.

I have three dashes (- - -) showing on the display. What does this mean?

Move the display closer to the transmitter and press the link button. If the dashes remain on the display this would indicate the transmitter and receiver are not communicating. Please contact efergy Customer Service to help locate the problem.

Backlight appears to work sometimes, and not other times. Is my display broken?

No. The backlight is on a timer to save battery life. The display should work at darker periods of the day, when any buttons are pressed.

For more information about the e2 and the elink software, go to www.efergy.com

SPECIFICATIONS

Model Name/Number: **efergy e2 1.0**

Frequency: **433.52MHz**

Transmission Time: **6s. 12s. o 18s.**

Transmission Range: **40-70m**

Voltage Range (in the sensor): **110V-400V**

Measuring Current: **50mA-95A**

Accuracy: **>90%**

The LED backlight will be activated **from 18:00Hrs to 6:00Hrs.**

Carbon ratio: **0,50 kg. CO₂ / kWh**

You will find some symbols on the monitor:

 Low battery warnings (monitor/transmitter)

 Alarm on/off

 Transmission sign (Link is OK).